

# Everyday excellence for everyone



Catalogue  
Shira





Catalogue  
Shira

# INDEX

Company	5
Shira	11
Connect	51
Strengths	59
Products	63



# COMPANY

Young, vibrant, and cutting-edge:  
At WM technics, innovation is our top  
priority - for both us and our clients.

Established in 1986, WM technics crafts premium **ice resurfacing machines** suitable for every surface and requirement. Our state-of-the-art models stand out with their advanced technology, user-friendly operation, certified safety, and contemporary design.

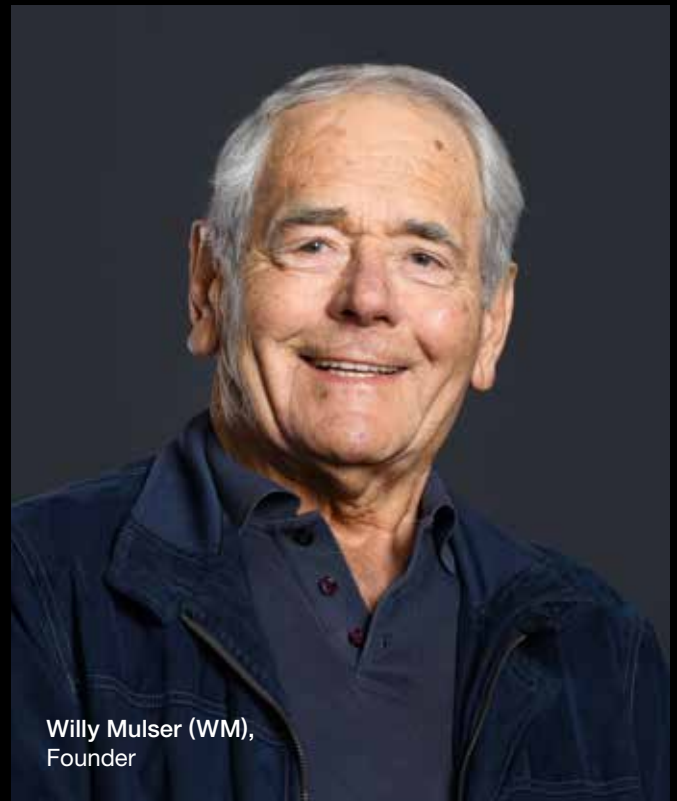

## Here's what we have to offer

Whether catering to professional ice needs within an arena or on a mobile rink, the distinction is minimal: WM technics consistently offers the optimal solution for any requirement. Owing to our relentless pursuit of product excellence, we pioneer cutting-edge standards and stand as a prominent leader in the worldwide market.

Powered by our robust digital infrastructure; design, parts production, and

the assembly of ice resurfacing machines are conducted at our South Tyrol-based facility (Italy).

In this manner, WM technics guarantees unparalleled quality, attending to every intricate detail. Custom setups built on customer specifications, reduced maintenance commitment, and steadfast assistance affirm WM technics as a powerful ally.



Florian,  
Assembly Team

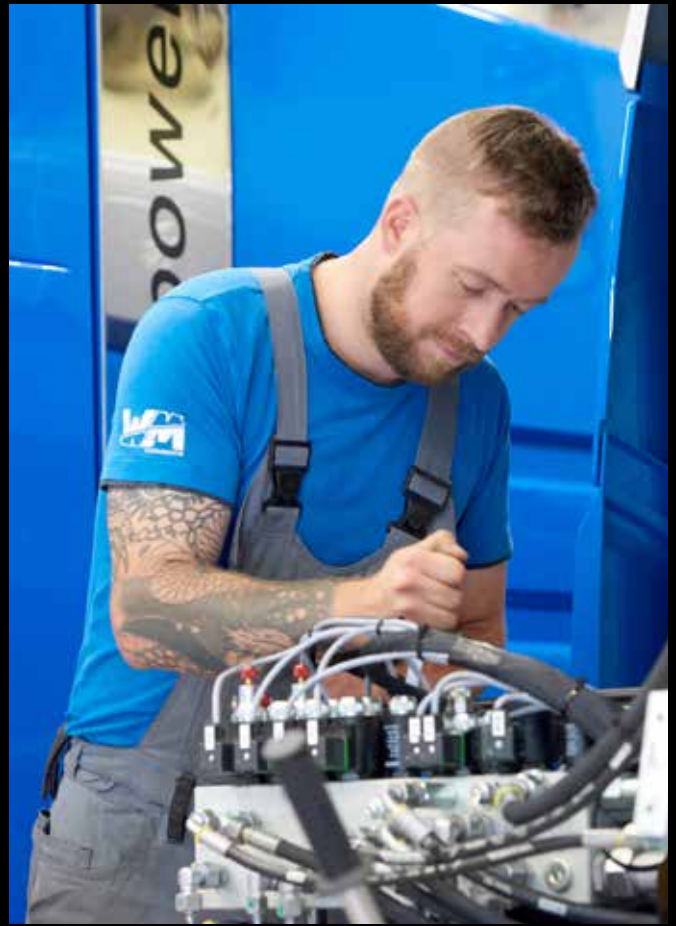



## Always Ahead of the Curve

With precision, we delve into research, trials, and systems. Our team's years of prowess in development, manufacturing, and setup culminate into a harmonious synergy.



## Safety at its Finest

Our cardinal rule: Prioritizing safety and well-being. WM technics' ice machines are designed with intuitiveness and uncompromised safety, meeting European machinery guidelines.



## Design with a Spark

WM technics brings to life trailblazing ice machines, always keeping the client and entire production lifecycle at heart.



## Precision Production

WM technics manufactures all its turning and milling components with utmost precision in its production department, only sourcing standard parts from reputable manufacturers. Each component is then customized in detail based on its function and crafted with the greatest care.



## Streamlined Assembly

WM technics champions the rapid production of ice machines, backed by rigorously organized processes. Every move is intricately mapped and transparent. Our commitment to precision minimizes the need for maintenance.



## 360-Degree Quality

WM technics designs and produces innovative ice resurfacing machines that meet all efficiency, reliability, longevity, and ease-of-use requirements. Series construction and in-house production also allow for the detailed tracking of all fabrication stages and utilized components.



## Sustainability with Vision

WM technics machines are designed to stand the test of time. We advocate for enduring products while keeping an eye on operational expenses. Balancing energy conservation, reduced consumption, and profitability doesn't deter us from delivering peak performance.



## Customer-Centric Assistance

Just as our machines care for the ice, we cherish our relationships with our customers: not only before the purchase but also during the commissioning and afterwards. We meet our clients' unique requirements even during the production process, tailoring our approach to their needs.



BORN ELECTRIC  
LITHIUM





# SHIRA

WM technics sets new standards  
in ice resurfacing with powerful,  
user-friendly, and spacious Shira.

# WM's powerful ice resurfer for stadiums is suitable for ice surfaces of **2,600 m<sup>2</sup> / 28,000 ft<sup>2</sup>**.

Powerful drives powered by electric motors and flexible combinations of snow and water tanks: The Shira is specially **designed for efficient ice resurfacing in stadiums**. It offers an excellent price-performance ratio and features a user-friendly control panel that makes operation extremely simple, thanks to clear information displays and an automatic mode. Additionally, quick access to all technical components ensures fast and cost-effective maintenance.

Superior ice quality right up to the boards: The Shira represents professional ice resurfacing for areas up to 2,600 m<sup>2</sup> / 28,000 ft<sup>2</sup>. Equipped with **a market-standard thick blade**, Shira handles even the most demanding tasks effortlessly, guaranteeing durability and precision for flawless results. Blade changes take just 5 minutes!

	<b>Snow tank volume</b>	3 m <sup>3</sup> / compacted 3.6 m <sup>3</sup> 106 ft <sup>3</sup> / compacted 127 ft <sup>3</sup>
	<b>Water tank volume</b>	1,000 l / 1,350 l / 1,750 l    264 gal / 356 gal / 462 gal + snow tank-water tank connection 2,000 l / 2,350 l / 2,750 l    528 gal / 620 gal / 726 gal
	<b>Blade width</b>	2,100 mm / 2,300 mm    82 5/8 in / 90 1/2 in
	<b>Fields of operations</b>	Pro / Ice stadiums

“The Shira has everything we need to resurface the ice in our stadium to perfection. We are absolutely delighted with it!”

**Jakub Kloz - Ice Master**  
KV Aréna Karlovy Vary  
(Czech Republic)





## Safety and protective features

At WM technics, safety and health protection always come first. A thorough and independent inspection carried out by [Suva](#), the accredited and recognized Swiss certification body, confirms compliance with the European Directive 2006/42/EC, which regulates the level of protection against machinery-related accidents to ensure user safety.

**suva**  
CERTIFICATION

In compliance with Suva certification No. E 7224/1.e

Highlight

# Great Usability

The Shira ensures **the utmost comfort for the driver.** Whether without a cabin or with a fully enclosed one, you'll always have a flawless panoramic view from the driver's seat.



### Cabin

The see-through, roomy cabin, equipped with a roof, door, and expansive windows – offers an unobstructed 360-degree perspective and shields you from all weather conditions.

### Steps and Seat

Three steps provide you with easy access to the comfortable driver's seat.

### Control Panel

The control panel allows you to conveniently control essential functions. Pressing the A/M button starts the automatic mode, activating all programmed workflows.

### Color Display

The high-resolution touch color display gives you an overview of all essential information.

Highlight

# The Passenger Seat

Anyone wishing to understand the work of an **ice master** can witness it firsthand from the passenger seat.

From the machine, during a break for instance, a fan can observe the playing field of their favorite team from an entirely new perspective. A magnificent gesture to offer fans as part of a contest or a raffle.

The passenger seat is always standard, not an optional extra.

**suva**  
CERTIFICATION



---

New business opportunities

---

Presenting the job of an ice master

---

Highlight

# Integrated Edger

Affixed directly to the Shiras's frame, the edger provides **unparalleled stability** and superior performance.

The user-friendly control of the sprung edger is safely managed from the driver's seat. The innovative horizontal suspension system with guide rollers ensures that the edger adapts optimally to the edge contours at a constant milling depth. In addition, excess ice is efficiently and cleanly removed.



With the combo of a swiveling brush and a rink edger, you can mill and clean the ice surface in a single go. The edger is located between the axles and in front of the brush, providing an optimal overview of the machine. When not in use, the edger remains tucked away between the wheels without affecting their operation.

The ice is polished with utmost precision at an exact 90° angle. This precision is assured by the direct mounting of the sprung edger onto the machine, ensuring the angle remains impeccably constant throughout the operation. When a puck is shot near the boards, one can observe it gliding seamlessly and stably over the ice, with no deviation.

In certain circumstances, due to condensation dropping from the ceiling, small ridges or mounds can form on the ice. These build-ups can pose a hindrance, but thanks to our edger, which is solidly attached to the machine, these mounds are effectively flattened. The edger, accurately oriented towards the ice elevation, consistently works to ensure the ice returns to a smooth and even state.

---

Perfect edge fitting

---

Milling and cleansing procedure

---

Horizontal suspension system

---

Highlight

# Flexible Brush

# A **robust brush** for tackling tough snow residues; fuss-free upkeep with its removable brush head.

Mounted on a arm, the brush can be operated hydraulically. An additional joint, complemented by gas springs and a guiding roller, ensures it traces the edge with pinpoint accuracy and the right pressure, even during swift movements. Crafted for resilience, the brush arm can withstand passage at top speeds, even with an open dasher board. Maintenance is a breeze; the brush head can be quickly swapped out with the simple turn of a screw.

An open dasher board? That's no hurdle! The brush arm, equipped with a gas spring, dynamically meets every challenge. It's built to last, confidently taking on any task.



---

**Precise with optimum pressure**

---

**Indestructible**

---

**Quick and easy**

---

Highlight

# High- performance Conditioner

Discover the high-performance conditioner from WM technics! With our planer unit we combine innovation with efficiency.

Our intuitive design ensures seamless ice resurfacing for the ultimate ice experience – where precision meets quality.

### Ice Cleaning System

Our perfectly positioned nozzles ensure that the recently planed surface is cleaned right after the blade. With the suction bar spanning the full length of the planer the contaminated water is consistently collected along the entire planing unit and safely transported to the snow tank.



### Replaceable Runners

Our conditioner come with plastic runners that ensure minimal resistance. Wear and tear? Simple replacement in just a few steps for continued performance.



Highlight

# System ICEplus

Opt for spraying over pouring - forget the towel: ICEplus's **low-pressure nozzles** deliver a denser ice that's game-ready in no time.



### Ditch the Towel

Gone are the days of using a towel for distribution; with ICEplus, water is directly sprayed on, enhancing efficiency and doing away with towel wear.

### Compact ice Quality

With the introduction of fine water particles, minimal air gets trapped within the ice, leading to a tighter, rapidly solidifying ice surface ready for use sooner.



### Control with Control Panel

The intuitive control panel emphasizes the easy operation of the Shira, allowing you to manage the machine smoothly.

### ICEplus Flexi

Combine the benefits of the modern water spray system with the tried-and-true towel method. Switch between the two techniques at the touch of a button and experience ultimate flexibility.

Highlight

# Snow tank- Water tank

When it comes to making ice or using a water fountain, you're going to need a lot of water. Thankfully, Shira has thought of that! They've designed it so that the water and snow tanks can merge into one, giving you a whopping total of over **2,000 liters / 528 gal of water.**



Water tank volume

1,000 l / 1,350 l / 1,750 l

264 gal / 356 gal / 462 gal



Snow tank volume

3 m<sup>3</sup> / compacted 3.6 m<sup>3</sup>

106 ft<sup>3</sup> / compacted 127 ft<sup>3</sup>



Snow tank-water tank connection

2,000 l / 2,350 l / 2,750 l

528 gal / 620 gal / 726 gal

# Snow tank-water tank connection

No more standing in cold water and tiresome tugging on hoses: All operations can be carried out from the comfort of the driver's cab.

Example 1:  
1,750-litre water tank  
+ 1,000-litre snow tank  
= 2,750 litres of water

Example 2:  
356 gal water tank  
+ 264 gal snow tank  
= 620 gal of water



In just a minute, you can connect the snow and water tanks, providing a water capacity of 2,000 liters / 528 gal. A digital display lets you see the fill level of the tanks.



Closed lock



Open lock: connected

## Tilting function and system for snow removal



---

Quick emptying

---

Even in adverse weather conditions

---

Teflon-finished surface

---

Safety

---

## Stable and durable frame

The snow tank is made of sturdy construction steel, forming a solid structure in tandem with the frame. After its creation, both the frame and the entire body undergo a painting process, originally designed for marine applications. This employs state-of-the-art technology adhering to the highest quality standards, ensuring a resistance of at least 1,200 hours against salt spray corrosion.

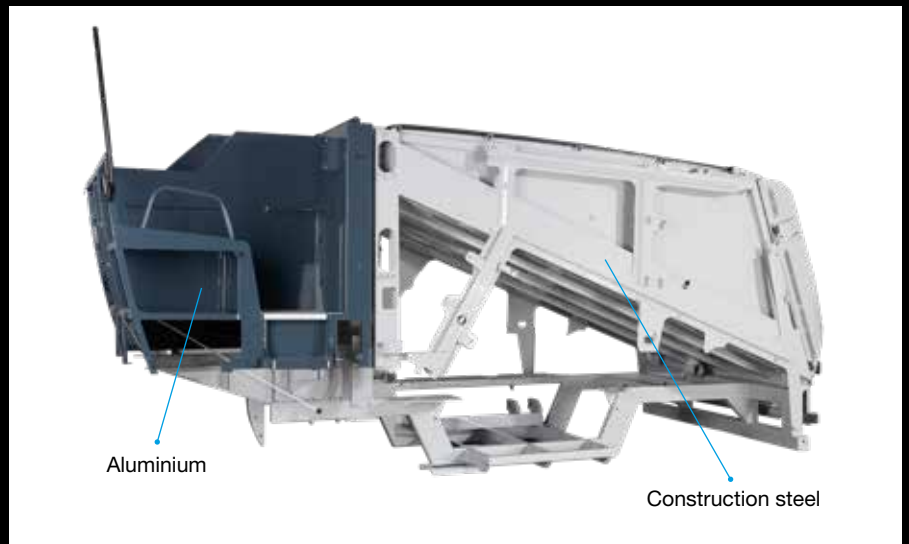

## Snow tank lid:

Sealed



Snow tank lid can be flipped open.



# Snow tank

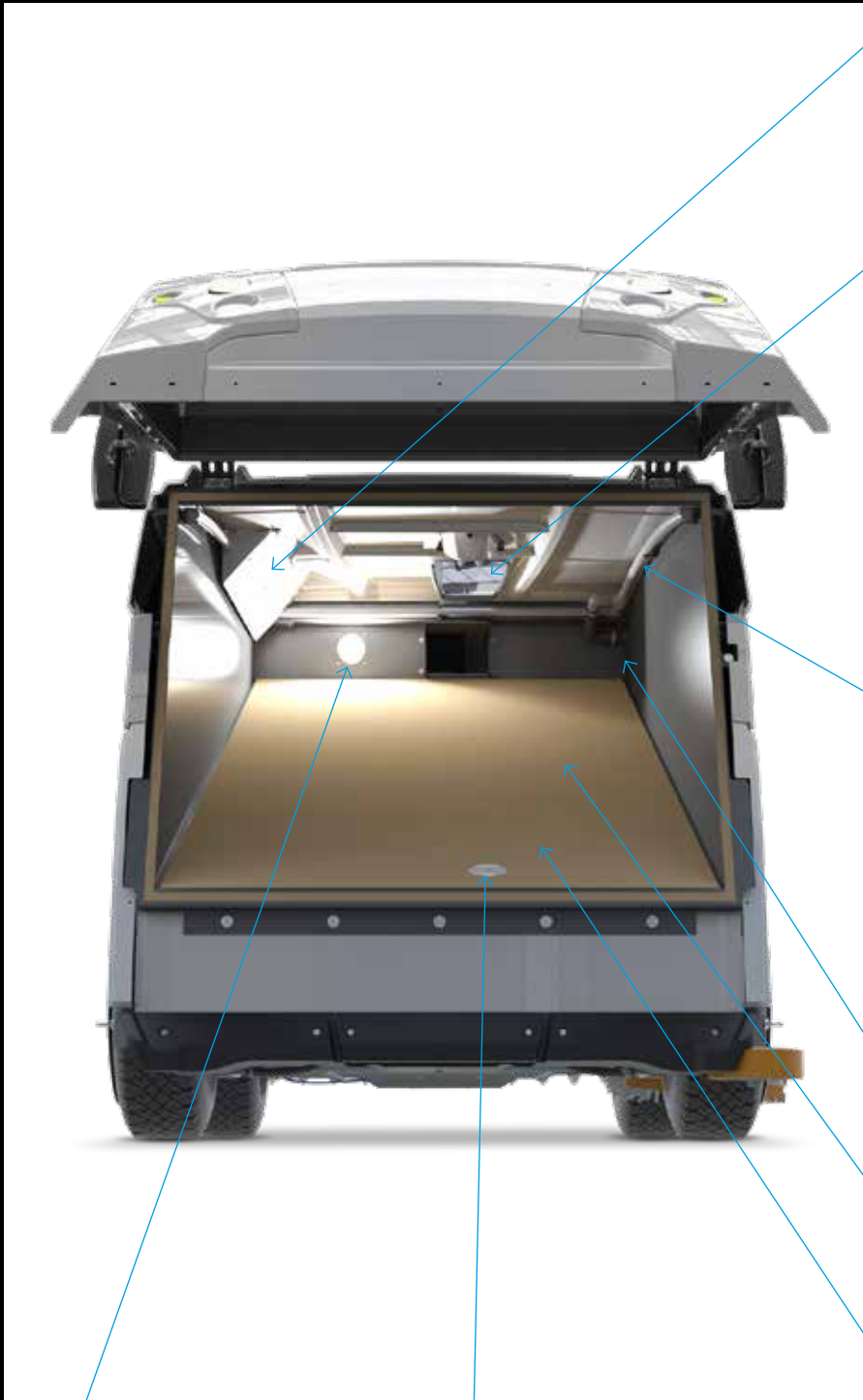

The ventilation of the snow tank, combined with the snow dust retention system, ensures a uniform and compact filling.



Large transparent inspection door for perfect visibility inside the snow tank.



Snow tank cleaning system: removes dirt and snow residues in just a few seconds.

The dual-cone snow tank allows for quick emptying, even under adverse weather conditions.

The steep inclination of the snow tank utilizes the effect of gravity, and along with its conical shape, ensures optimal snow compression.

Teflon-coated base for clean emptying.

Powerful LED lighting for the snow tank ensures perfect visibility.

Partition lid (connection between snow and water tank).

Highlight

# Three Braking Systems

Our braking technology blends the mechanical braking approach with **energy recuperation** - the hallmark of a true electric vehicle. Explore our groundbreaking system.

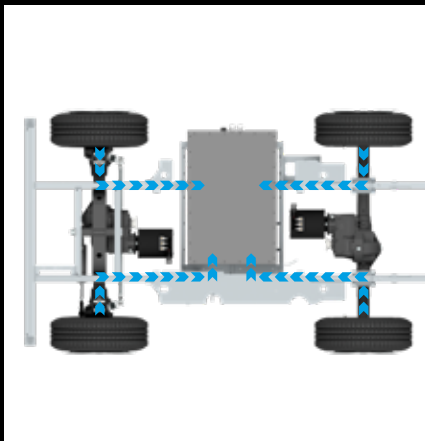

1

### Electromagnetic recuperation

By harnessing the energy recovery function of the electric drive system during movement, electric power is regenerated for the battery. This technology significantly boosts the ice resurfacers' operational range and reduces the reliance on secondary braking systems. The system affects all four wheels.

2

### Service Drum Brake System (Option)

For added braking capability, especially on sloped terrains like ramps, the machine comes with drum brakes on two of its wheels or all four. Each wheel's braking force stands at 3,800 Nm. A hydraulic brake booster enhances the braking strength.

3

### Automatic Holding Brake

Targeting both rear wheels, it operates via a spring mechanism. It automatically activates once the machine is shut down, ensuring no unintended rolling. It exerts a braking force of 4,000 Nm on each wheel.

Highlight

# System Dual Drive

Dual Drive is an intelligent control system that guarantees **optimal traction** on the ice by ideal power distribution between the front and rear axles.

With intelligent speed and torque control, even tight turns are handled without drivetrain stress, offering perfect driving dynamics and excellent energy efficiency.

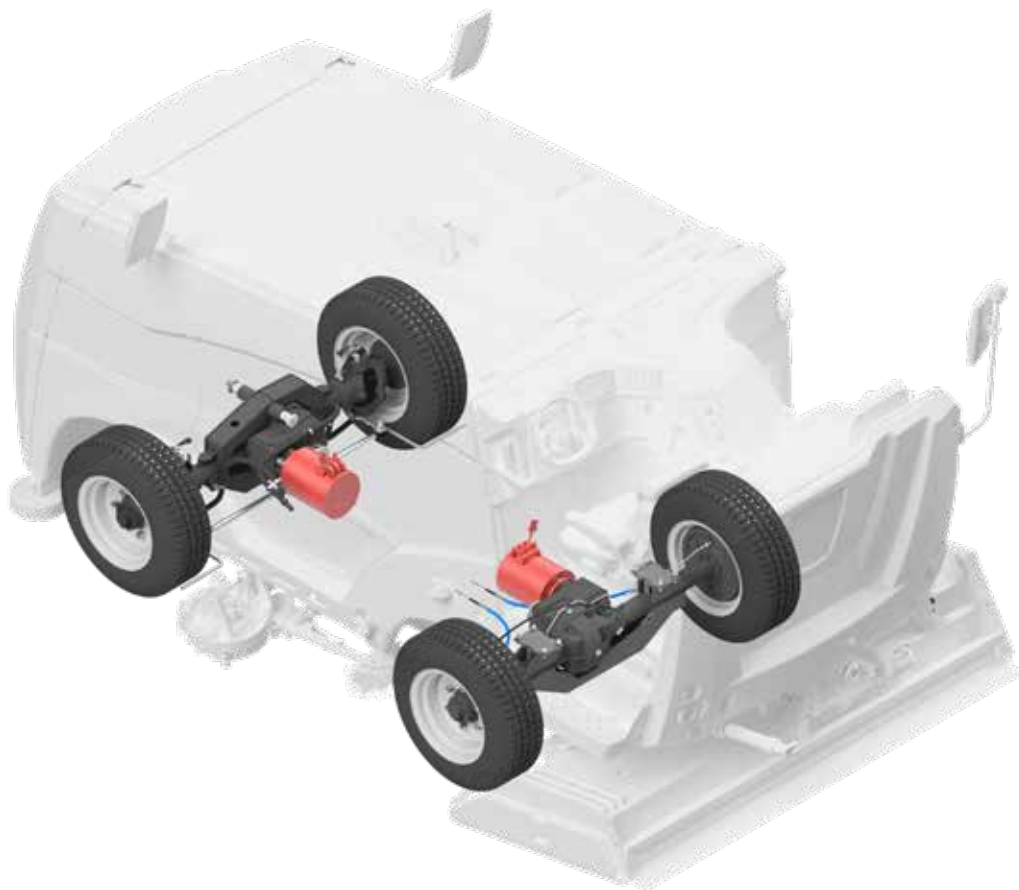

Highlight

$\text{LiFePO}_4$

Lithium battery

LiFePO4 batteries deliver **robust performance while being eco-friendly**, lacking harmful heavy metals and being mostly recyclable. Installed in Shira, they stand as an eco-optimized solution meeting top-tier demands.

### Performance

The lithium iron phosphate battery not only ensures extended longevity but also provides a consistent and reliable power supply.

### Sustainability

LiFePO4 batteries are free from toxic heavy metals and are almost 100% recyclable, with a lifespan of 3-4 times as many charging cycles as lead acid batteries.

### Center of gravity

Our centrally and deeply positioned battery not only ensures maximum stability but also optimizes the overall balance of the machine.

### In-house Assembly

Battery packs are specifically tailored to machine requirements and are assembled in-house, ensuring quality and adaptability.



# TECHNOLOGY

Shira **sets new standards** in ice resurfacing: Its forward-thinking design combined with precise and perfectly tuned mechanics ensures maximum performance on the ice.



The Shira impresses with its blend of elegance and resilience: Its tail end, exquisitely shaped from a rust-resistant, lightweight alloy, guarantees a harmonious weight balance and energetic, cost-effective movement. Perfect weight allocation between the anterior and posterior axles, coupled with a lowered center of mass, promises superb turns on icy terrain.

When raising the hydraulic canopy, an organized engine compartment unveils itself. Centrally located, the vibration-dampening hydraulic oil reservoir equipped with a built-in electric motor that varies its rotation speed based on requirements, ensuring a quiet performance.

All electric valves are neatly assembled on the left in a custom-built hydraulic unit.

On the right side, the motor bay shelters water-resistant electronics adhering to contemporary off-highway norms.

# Technical specifications

## Shira

Motor	5 asynchronous motors Optional 6 asynchronous motors
Power rating	31 kW (33 kW)
Water tank	1,000 l 264 gal / Optional: 1,350 l 356 gal / 1,750 l 462 gal
Snow tank	3 m <sup>3</sup> 106 ft <sup>3</sup> / compacted 3.6 m <sup>3</sup> 127 ft <sup>3</sup>
Transmission	Continuously adjustable electric all-wheel drive
Speed	0 - 13 km/h 0 - 8 mph
Tyres	225 / 75 / R16C with 6 rows of spikes
Wheel rims	9" x 16"



CE



**suva**  
CERTIFICATION

In compliance with Suva certification No. E 7224/1.e

# Standard equipment

## Machine

PLC control
Easily accessible engine compartment (tiltable) with cab support
Hydraulic oil tank: 50 l / 13 gal
Maintenance-free asynchronous motors
Service brake with hydraulic brake force booster
Hydraulic negative parking brake
Snow bin & water tank connection (> 2,000 litres / > 528 gal)
Electrical snow bin inspection hatch
Coated snow bin
Snow bin headlight, side headlight
Water tank made of PE
Function for automatic water filling system with immobilizer
Hydraulically driven and swivelling side brush
Board guide pulley
Side & rear mirror
Flashing warning light
Acoustic signal for reverse drive, snow bin cover operation and reverse of the screw conveyors

## Cockpit

Spring-suspended and height-adjustable driver's seat with armrests
Spring suspended passenger seat
High-resolution 7" touchscreen
Button for automatic mode: operations start automatically in a fixed order

## Planing system / Conditioner

Constant grinding pressure planing system
System for water dosing in curves
2 blades
2 towels

# Dimensions

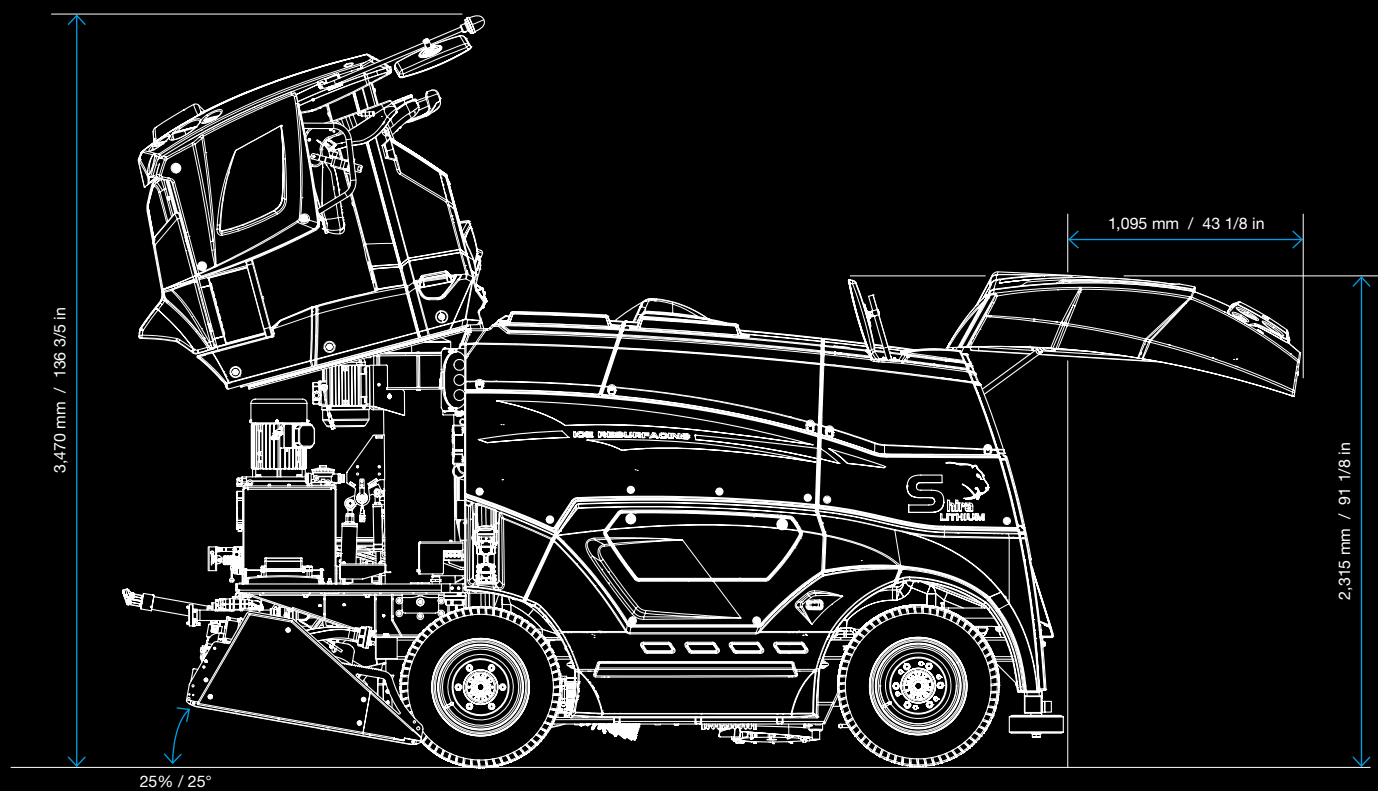
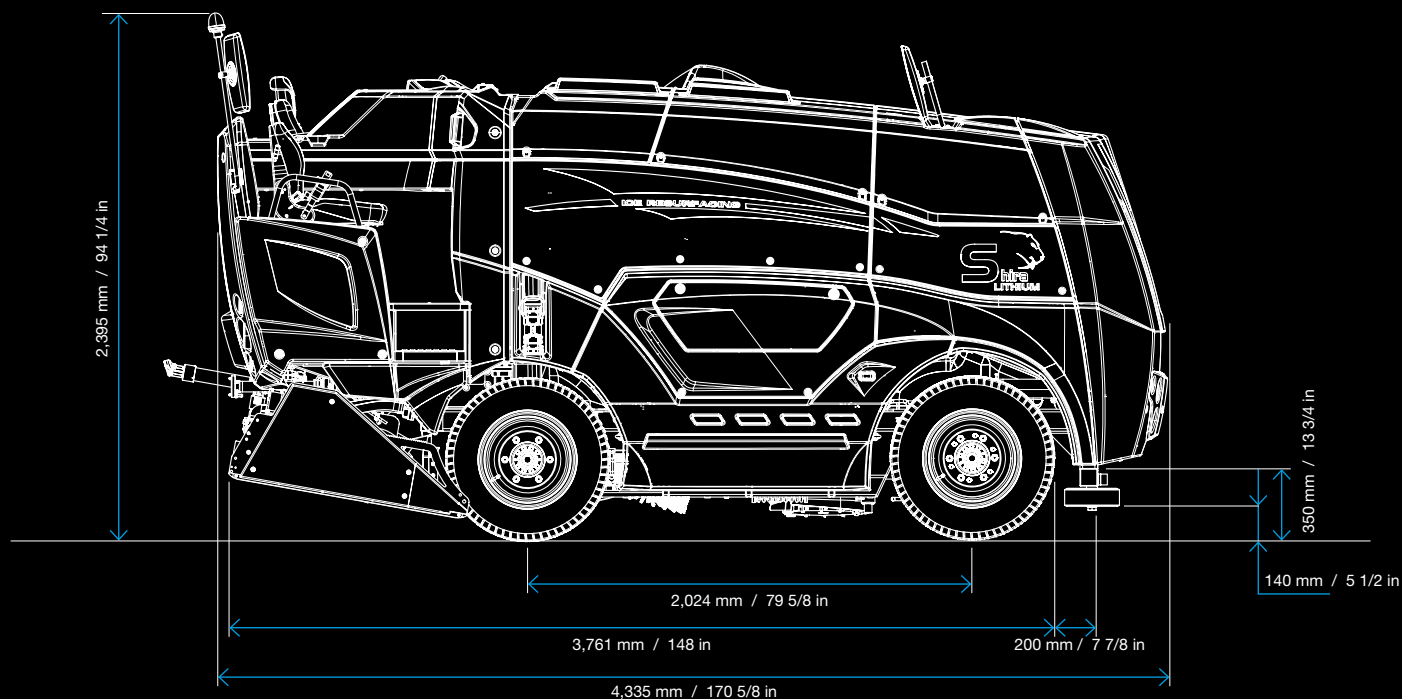

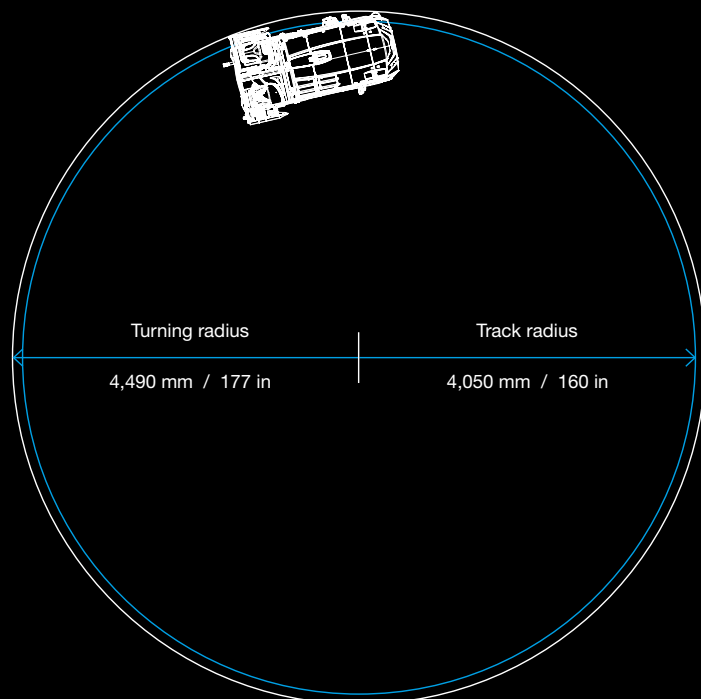
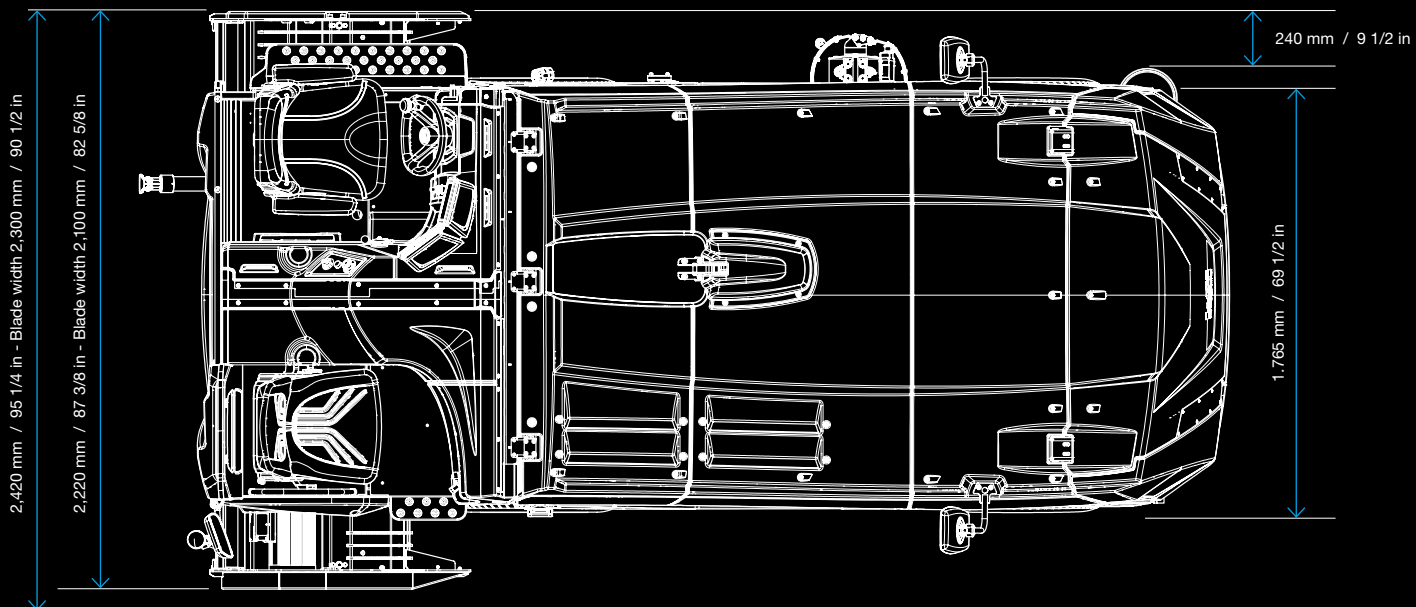

# Optional

Cabin with panoramic windows



---

## Water dosing and wash system



Water pump



Ice wash system  
Multijet  
*with suction ledge*



Screw conveyor  
wash system  
vertical  
*can be activated during  
ice resurfacing*



Screw conveyor  
wash system  
horizontal  
*can be activated during  
ice resurfacing*



Snow bin wash  
system



Wheel wash  
system with  
co-steering

---

## Water application



Towel lifter  
automatic



ICEplus  
*Water spraying system*



ICEplus Flexi  
*Water spraying system  
with automatic towel lifter*



Water fountain

---

## Overview and security



Side mirror  
front left



Side mirror  
front right



Heated mirrors



Acoustic distance  
warning system  
front



Front camera



Rearview camera



Two cameras with  
10" display  
and recording function

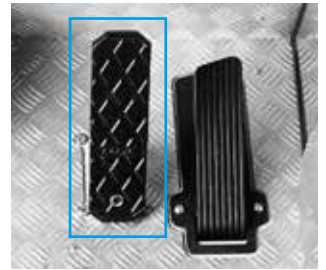

Service brakes

---

## Dasher board processing



### Edger

*in galvanised steel,  
spring-mounted and  
electric height adjustment*

---

# Comfort



Windshield made of real glass  
*with wiper system*



Cabin with panoramic windows



Cabin heating



Driver's seat heating  
*Seat pad*



Radio  
*with 2x 10 cm speakers*



Acquastop valve

---

# Personalization



Painting



Wrapping

---

# Lighting



Low-beam headlights



High-beam headlights with parking lights



Tail lights  
*Parking light and brake light*



Reversing lights



Turn signal  
*front, rear and side*



Complete lighting system  
*for compliance with road traffic regulations*



LED daytime running light



RGB underbody illumination

---

# Remote Maintenance and Machine Control



Connect



Laser Blade Control System

---

## Service



Battery trolley



Spare tyre 16"



Cross-key



Lifting jack with bar



Assembly tool for nozzles ICEplus



Comfort blade change system



Conditioner tilting device



Sharpener for industrial blades

---

## Bavarian Curling



Groove harrow

# MAINTENANCE AND WARRANTY

Simply tilt the cabin to access all the technical components in the engine compartment. This allows the technician to work quickly and cleanly, saving on service time and costs. Thanks to remote maintenance, our team can also monitor the machine's condition and address any potential issues.



---

Free and easy access

---

Skilled remote maintenance

---

Low service costs

---

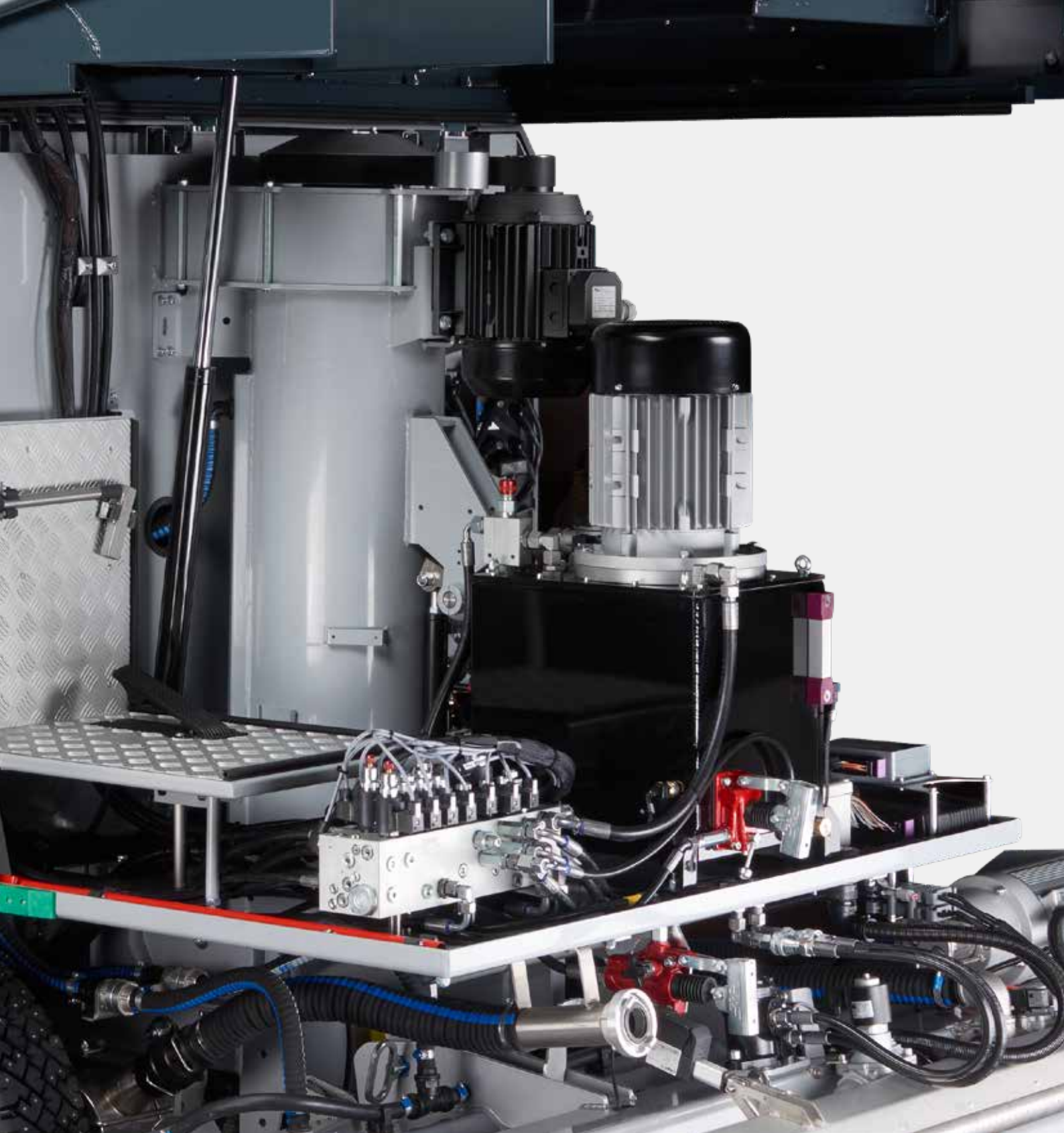

High quality has a significant advantage: Service costs in the coming years will be very low, and we can prove it. When considering the total costs, including purchase and maintenance, Shira is clearly the leader in its class and sets new standards.



# CONNECT

Connect:

A data tool, communication assistant,  
and e-shop all in one system - and your  
guarantee for sustainable ice!

Connect is an all-in-one data tool, communication assistant and e-shop. **Analyse and optimise** your machine's resource consumption to optimise your budget planning. Maintain a consistently high level of ice quality through data analysis and controlled application of ice resurfacing implements.

Automatic status messages enable you to monitor the status of your machine at all times. Provide your service staff with over-the-air direct access to resolve problems or carry out software updates. Access the interactive workspace and order spare parts quickly and easily.

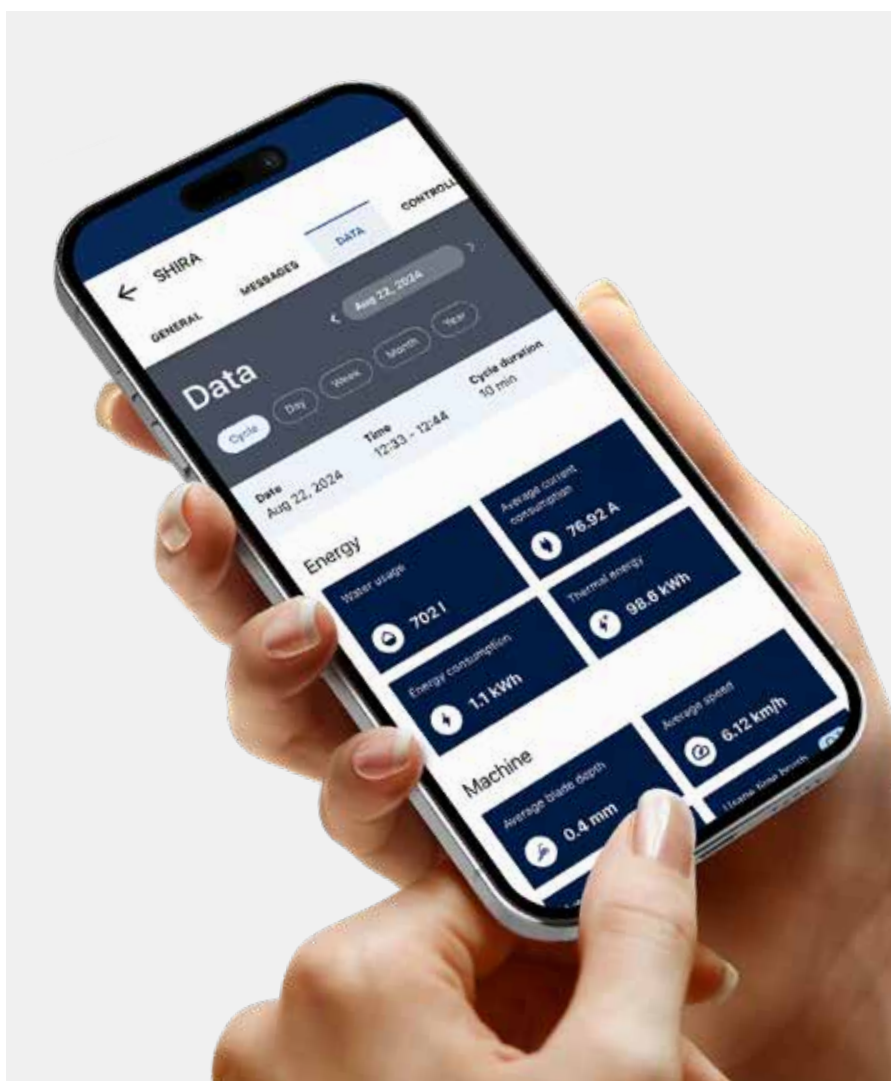

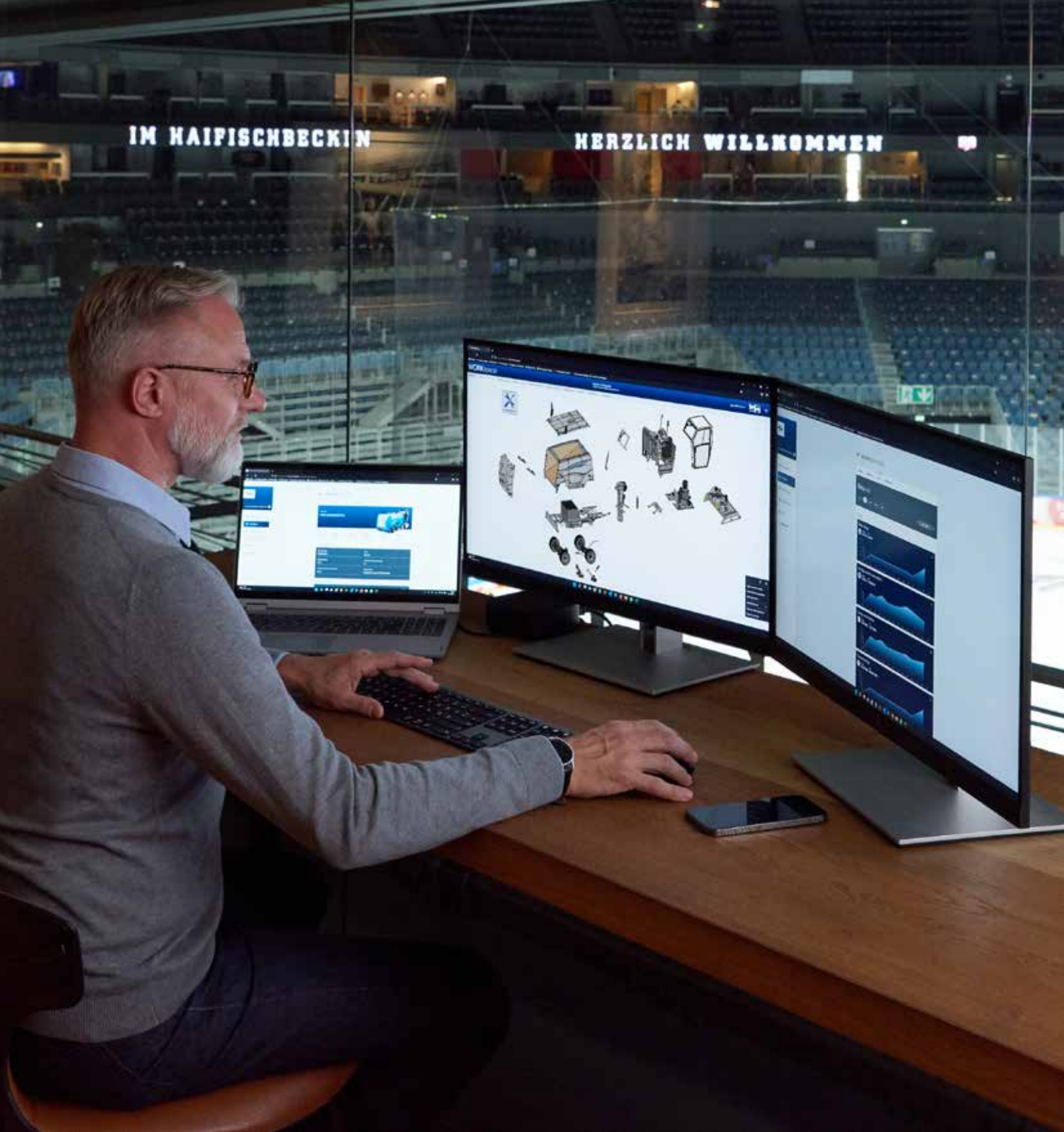

Questions about budgeting? Sustainability? Connect gives you answers. Energy costs are rising. And so is environmental awareness. With Connect, we help you to groom your ice sustainably in every way.

---

# Sustainable budget planning through detailed analysis

---

## Real-time data preparation

This data shows you precisely how much energy and water is used during each usage.

---

## Long-term data analysis

Experiment, analyse and discover how much money and resources you use to create the perfect ice surface.

---

## Sustainable budget planning

Detailed data information enables you to plan your energy consumption and water budget with pinpoint precision.

---

## Let's Break the Ice

Connect guarantees immediate support.

---

## Multimedia

Connect prepares real-time consumption data and displays it on all platforms (App, tablet, desktop).

---



---

# Sustainable support through reduced service trips

---

## Automatic notifications

Connect automatically provides you with errors, pending system updates and your next service.

---

## Over-the-Air

Service staff have direct access (over-the-air) to your machine and can thus diagnose errors or initiate pending updates immediately.

---

## Immediate support

This allows our service technicians to carry out troubleshooting services immediately and directly, without having to be on site. The same applies to system updates.

---

## Sustainable support

Connect over-the-air support enables you to make savings on countless costly, resource-intensive service trips. Service staff only have to attend your premises in emergencies and during on-site servicing.

---

## Let's Break the Ice

Connect helps you to avoid lengthy downtimes that impact on efficiency.

---





---

# Sustainable environment through controlled resource consumption

---

## Controlled water consumption

Precision data processing provides you with a constant overview of water consumption and the option of reducing consumption if necessary.

## Optimised energy consumption

The same applies here: Monitor the energy consumption of your ice resurfacing so that you know exactly the adjustments you need to make in order to reduce consumption.

## Remote support

Over-the-air access enables service staff to access your machine directly and provide you with skilled support, and helps you to cut down on costly, resource-intensive procedures.

## Environmental sustainability

Save water, reduce water consumption to a minimum, avoid unnecessary service trips – and in doing so, help to protect the environment as well as your finances.

## Let's Connect to the Ice

Resurface your ice more sustainably than ever before.

---





# STRENGTHS

WM technics - Excellence in design and quality. In-house manufactured machines. Easy maintenance. Quick access to spare parts. Your guarantee for the highest standards.

At WM technics, we strive for excellence at every stage of our work. Our machines are the result of high-quality components and meticulous design that minimizes maintenance effort. Designed, manufactured, and assembled in our own facilities, we guarantee top quality and timely deliveries. From component to the finished product - every step is closely monitored to deliver to you **the ice resurfacing machines of the future.**

## User friendliness



Through the use of top-quality components together with a well-planned design, maintenance work is extremely simple and is reduced to a minimum.

## Quality guarantee



Our products are developed, manufactured, and assembled in-house at our facilities. This is the only way we can guarantee the best quality and punctual delivery times.

## The right replacement part, every time



Order your spare parts easily and conveniently from our online portal: Our series number and digital image system enable you to find the part you need with just one click.

## Series production



All WM technics vehicles are series-manufactured. We know exactly which parts have been used in each series run, and can deliver the correct spare parts to you at all times. At the same time, a number of optionals can be retrofitted with minimum effort and maximum precision, even years later.

## Service and support



Our well-networked, international team of technicians undergo constant training and will be delighted to help you whenever you require assistance.

## Quality consciousness



From the manufacture of individual parts right through to the final quality-control inspection: Every step of the process is carried out and monitored with the utmost precision. Each and every member of our staff is well-trained in his specialist field, and carries out all tasks conscientiously. This is a great advantage for our customers, who can be sure of receiving a technologically sophisticated product which has been manufactured to the very highest quality standards.



# PRODUCTS





Dive into the world of WM technics: Where cutting-edge design meets top-notch quality. Here begins the journey to top-tier ice resurfacing machines and #perfectice.

# Mammoth

An autonomous and innovative ice resurfacing machine, ideal for stadiums and large ice surfaces up to 2,600 m<sup>2</sup> / 28,000 ft<sup>2</sup>.

Maintenance-free AC motors, generous tank volumes, and the quick-change blade system ensure fast and efficient ice preparation. The compact design and frame-mounted edger provide maximum stability and exceptional maneuverability.







 Snow tank volume	3 m <sup>3</sup> / compacted 3.6 m <sup>3</sup> 106 ft <sup>3</sup> / compacted 127 ft <sup>3</sup>
 Water tank volume	1,000 l / 1,350 l / 1,750 l 264 gal / 356 gal / 462 gal + snow tank-water tank connection 2,000 l / 2,350 l / 2,750 l 528 gal / 620 gal / 726 gal
 Blade width	2,100 mm / 2,300 mm / 2,500 mm 82 5/8 in / 90 1/2 in / 98 1/2 in Blade change < 60 seconds
 Fields of operation	Pro / Ice stadiums

# Shira

The machine adapts perfectly to every ice resurfacing requirement in stadiums with ice surfaces up to 2,600 m<sup>2</sup> / 28,000 ft<sup>2</sup>.

It runs electrically and operates almost silently. The intuitive control via keyboard, display, and automatic mode enables particularly easy operation and maintenance. Thanks to excellent accessibility for manual interventions, it ensures noticeable cost savings and impresses with an outstanding price-performance ratio.



 Snow tank volume	3 m <sup>3</sup> / compacted 3.6 m <sup>3</sup> 106 ft <sup>3</sup> / compacted 127 ft <sup>3</sup>
 Water tank volume	1,000 l / 1,350 l / 1,750 l 264 gal / 356 gal / 462 gal + snow tank-water tank connection 2,000 l / 2,350 l / 2,750 l 528 gal / 620 gal / 726 gal
 Blade width	2,100 mm / 2,300 mm 82 5/8 in / 90 1/2 in
 Fields of operation	Pro / Ice stadiums





# evo<sup>2</sup>

The powerful ice resurfacing machine for intensive operations on large ice rinks and in stadiums – ideal for ice surfaces from 4,200 m<sup>2</sup> / 45,200 ft<sup>2</sup>.

The generously combinable snow and water tank volume offers maximum flexibility, while diesel, gasoline, or electric motors provide the drive as needed.

The very fast blade change system, excellent overview of all operating functions, and automatic mode significantly facilitate handling. Thanks to quick access to the engine compartment, maintenance is also particularly fast and cost-efficient.







 Snow tank volume	4.1 m <sup>3</sup> / compacted 5.1 m <sup>3</sup> 145 ft <sup>3</sup> / compacted 180 ft <sup>3</sup>
 Water tank volume	1,200 l / 1,400 l / 2,000 l 317 gal / 370 gal / 528 gal + snow tank-water tank connection 2,550 l / 2,750 l 674 gal / 726 gal
 Blade width	2,300 mm / 2,500 mm 90 1/2 in / 98 1/2 in Blade change < 60 seconds
 Fields of operation	Pro / Ice stadiums

# Compact

The compact ice resurfacing machine was specifically designed for small ice surfaces and rinks up to 1,200 m<sup>2</sup> / 12,900 ft<sup>2</sup>.

It is robust, easy to operate, and delivers shaving results like a large professional model. Thanks to its high maneuverability, it offers the driver first-class comfort and guarantees professional ice preparation – even on mobile ice rinks, it ensures ice quality at the highest level.







 Snow tank volume	1.8 m <sup>3</sup> / compacted 2.25 m <sup>3</sup> 63.6 ft <sup>3</sup> / compacted 79.5 ft <sup>3</sup>
 Water tank volume	600 l 158 gal
 Blade width	1,700 mm 66 7/8 in
 Fields of operation	Event / Small ice rinks

# Pinguino

The compact revolution among ice resurfacing machines: Thanks to its small dimensions, it moves with extreme agility and delivers precise, high-quality ice preparation for events and mobile ice rinks up to 800 m<sup>2</sup> / 8,600 ft<sup>2</sup>.

It offers the performance of large professional machines – shaves the ice efficiently and ensures perfect ice quality at all times. The unique forward seating position provides the driver with excellent visibility and high driving comfort.





	Snow tank volume	1 m <sup>3</sup> / compacted 1.25 m <sup>3</sup> 35.3 ft <sup>3</sup> / compacted 44.2 ft <sup>3</sup>
	Water tank volume	340 l 90 gal
	Blade width	1,400 mm 55 1/8 in
	Fields of operation	Event / Small ice rinks

# Snip

The electrically operated, manually guided edger makes ice maintenance considerably easier.

Whether mobile ice rinks or large arenas – it combines a compact design with modern, emission-free technology. Its most innovative feature is the quick, tool-free switching between two operating modes: lateral milling along the boards and frontal milling to remove ice build-up and unevenness. With an integrated drive, adjustable speed, and certified safety, it is a versatile and precise tool for maintaining any ice surface.



	Electric engine	24V / 130Ah (powered by a FAAM TRALEG battery)
	Blade width	Ø 350 mm Ø 13.8 in
	Fields of operation	Event / Ice stadiums



WM technics GmbH

Plant 1, Headquarters  
Breiener Straße 15  
I-39053 Blumau  
T. +39 0471 353 332  
info@wm-technics.com  
wm-technics.com

Plant 2  
Giuseppe-di-Vittorio-Straße 18  
I-39100 Bozen

Follow us on

YouTube: *WM ice*  
Facebook: *WM ice*  
Instagram: *WM ice*  
LinkedIn: *WM technics*



